



# PRODUCT SPECIFICATION

**Model No : CSD-424G/425G**

## Descriptions:

- 0.4 Inch Dual Digits Display
- CSD-424: Common Anode
- CSD-425: Common Cathode
- Emitting Color: Yellow Green



CUSTOMER APPROVED SIGNATURES	APPROVED BY	CHECKED BY	PREPARED BY

**CHINA SEMICONDUCTOR CORPORATION**

Address:2FL. NO.909,Chung-Cheng Road,  
Chung-Ho City Taipei Hsien,Taiwan.

Tel:886-2-2223-9696  
Fax:886-2-2223-9377

**OPTO PLUS TECHNOLOGIES CO.,LTD**

Address:696 Shun jiang Rd.,Ji Shan St.Shaoxing,  
ZheJiang,China

Tel:86-0575-8623888  
Fax:86-0575-8623112



**Model No : CSD-424/425G**

**Features -**

1. 0.4 inch (10.1mm) dight height.
2. Case mold type.
3. RoHs compliant.
4. Low power consumption.
5. Easy mounting on P.C. board or socket.

**Device Selection Guide -**

Part No.	Chip		Description
	Material	Emitted Color	
<b>CSD-424G</b>	<b>GaAsP</b>	<b>Yellow Green</b>	<b>Common Anode</b>
<b>CSD-425G</b>	<b>GaAsP</b>	<b>Yellow Green</b>	<b>Common Cathode</b>

**Package Dimensions -**

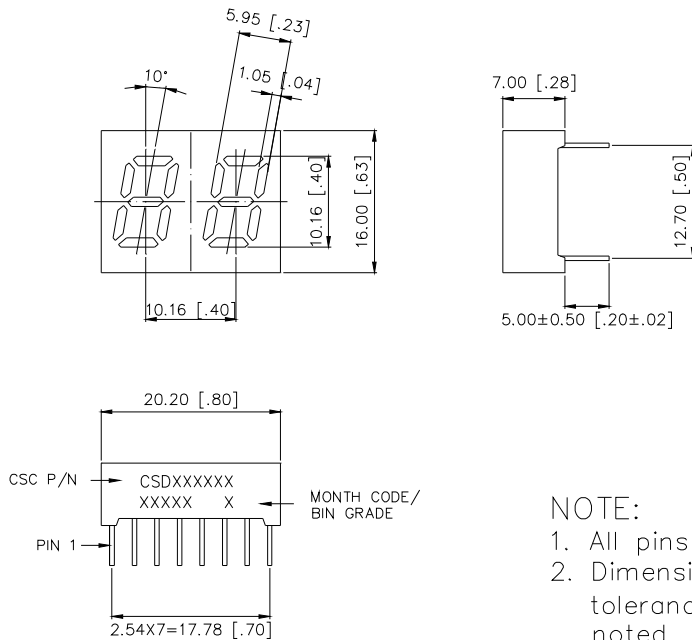

**NOTE:**

1. All pins are  $\phi 0.5$  (.02).
2. Dimension in millimeter (inch), and tolerance is  $\pm 0.25$  (.01) unless otherwise noted.



Model No : CSD-424/425G

Internal Circuit Diagrams -

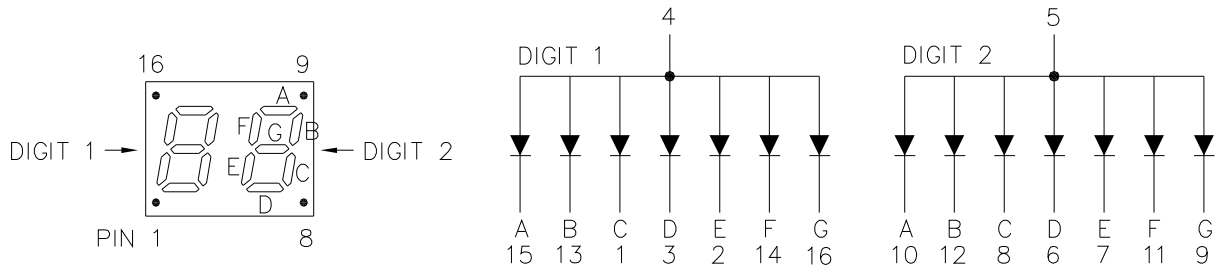

CSD-424 Common Anode.  
(CSD-425 Common Cathode.)

Absolute Maximum Rating -

(Ta=25°C)

Parameter	Symbol	Rating	Unit
Power Dissipation Per Dice	<b>Pd</b>	70	mW
Continuous Forward Current Per Dice	<b>IAF</b>	25	mA
Peak Current Per Dice(Duty cycle 1/10,1KHz)	<b>IPF</b>	90	mA
Derating Linear From 25°C Per Dice	-	0.33	mA/°C
Reverse Voltage Per Dice	<b>VR</b>	5	V
Operating Temp.	<b>Topr</b>	-35 ~ +85	°C
Storage Temp.	<b>Tstg</b>	-35 ~ +85	°C
Solder temperature 1/16 inch below seating plane for 3 seconds at 260°C			



Model No : CSD-424/425G

■ Electro-optical Characteristics -

(Ta=25°C)

Parameter	Symbol	Min.	Typ.	Max.	Unit	Condition
Forward Voltage Per Segment	V <sub>F</sub>	-	2.1	2.8	V	I <sub>F</sub> =20mA
Luminous Intensity Per Segment	I <sub>v</sub>	-	3.5	-	mcd	I <sub>F</sub> =10mA
Peak Emission Wavelength	λ <sub>p</sub>	-	570	-	nm	I <sub>F</sub> =20mA
Dominant Wavelength	λ <sub>d</sub>	-	568	-	nm	I <sub>F</sub> =20mA
Spectrum Radiation Bandwidth	Δλ	-	30	-	nm	I <sub>F</sub> =20mA
Reverse Current	I <sub>R</sub>	-	-	100	μA	V <sub>R</sub> =5V
Luminous Intensity Matching Ratio	I <sub>V-m</sub>	-	-	2:1	-	I <sub>F</sub> =10mA



**Model No : CSD-424/425G**

**Typical Electrical / Optical Characteristics Curves -**

**(Ta = 25°C Unless Otherwise Noted)**

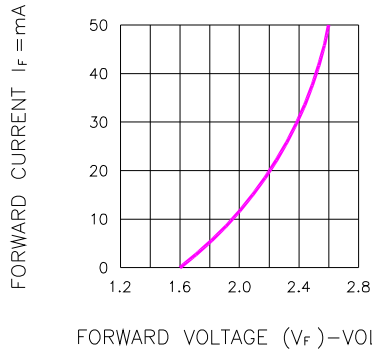

Fig.1 FORWARD CURRENT VS. FORWARD VOLTAGE

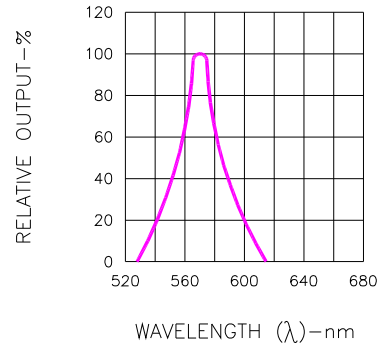

Fig.2 SPECTRAL RESPONSE

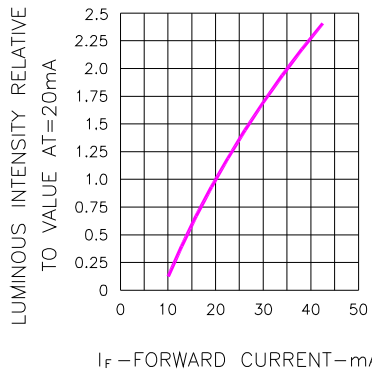

Fig.3 RELATIVE LUMINOUS INTENSITY VS. FORWARD CURRENT

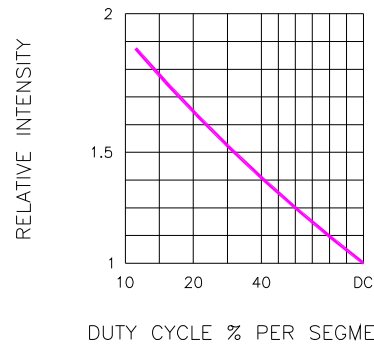

Fig.5 LUMINOUS INTENSITY VS. DUTY CYCLE

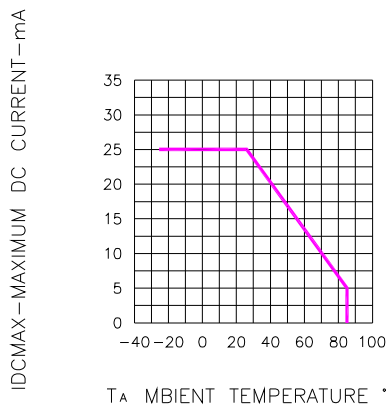

Fig.4 MAXIMUM ALLOWABLE DC CURRENT PER SEGMENT VS. A FUNCTION OF AMBIENT TEMPERATURE

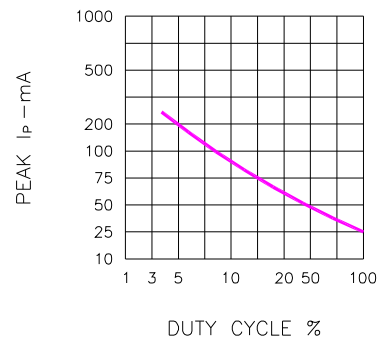

Fig.6 MAX PEAK CURRENT VS. DUTY CYCLE % (REFRESH RATE f=1 KHz)